

CAT MINER - FOOTSHAFT KIT
DA-550 CHAIN

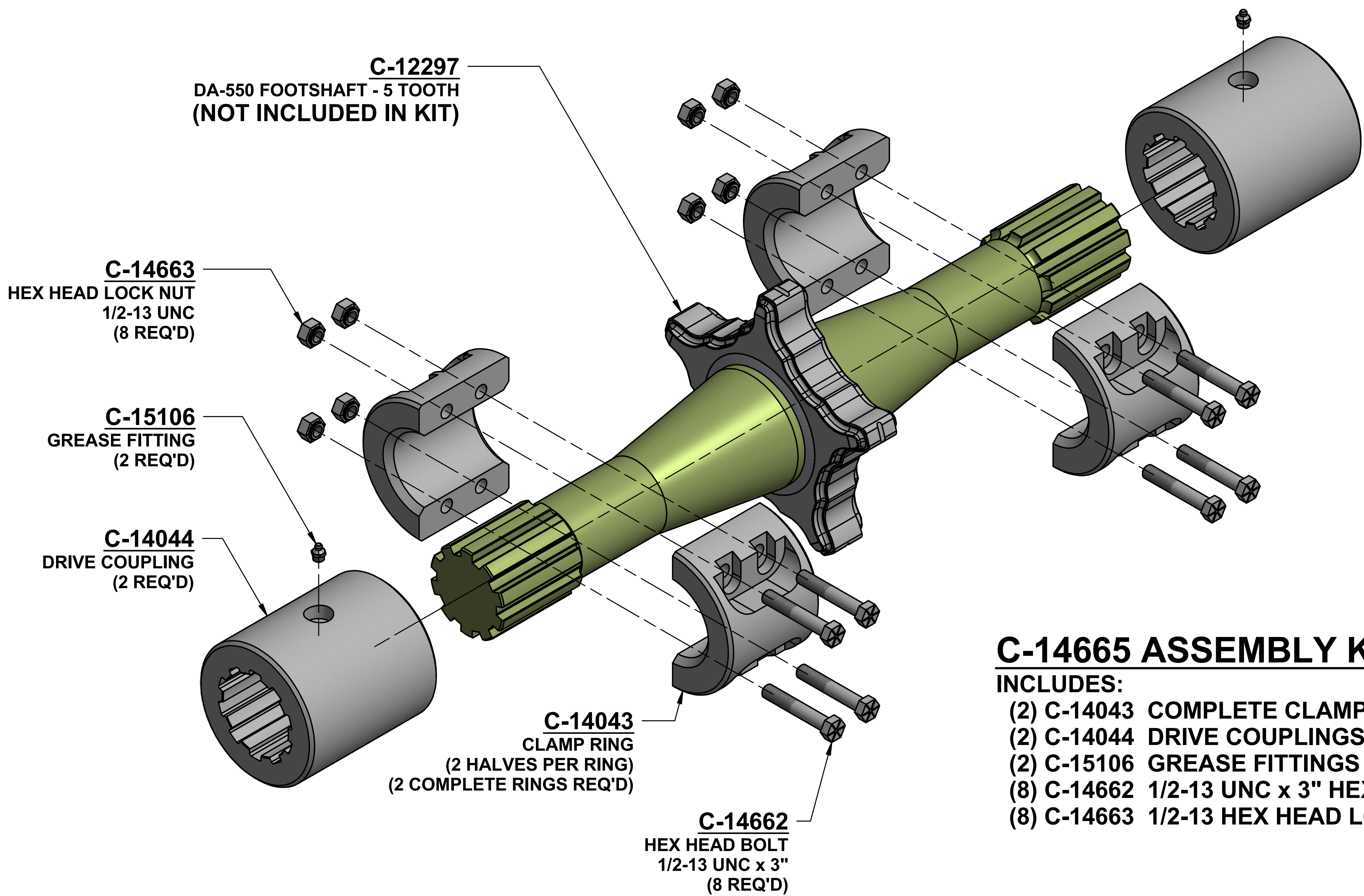

C-14665 ASSEMBLY KIT

- INCLUDES:**
- (2) C-14043 COMPLETE CLAMP RINGS
 - (2) C-14044 DRIVE COUPLINGS
 - (2) C-15106 GREASE FITTINGS
 - (8) C-14662 1/2-13 UNC x 3" HEX HEAD BOLTS
 - (8) C-14663 1/2-13 HEX HEAD LOCK NUTS